

- Kiinteät lasit 20.8Lp (1010.2) tai vastaava R_w 42 dB
- Kirkas laminoitu
- Umpiovi R_w 42 dB

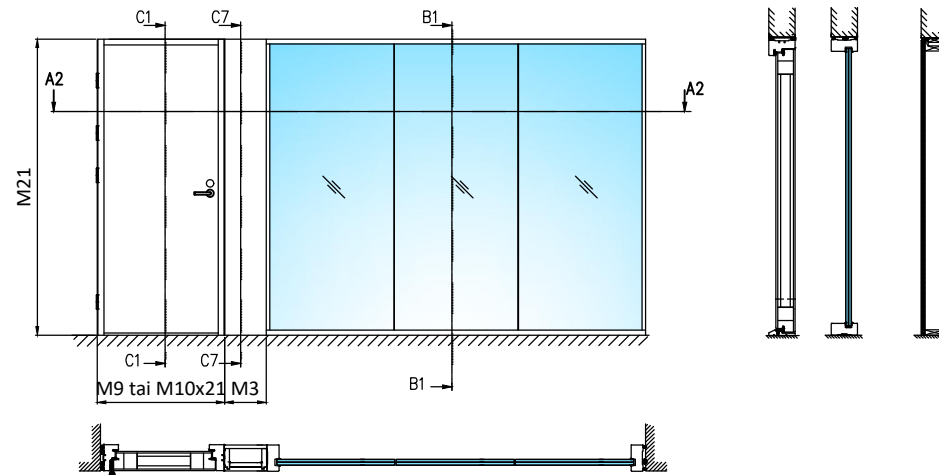

- Kiinteät lasit 20.8Lp (1010.2) tai vastaava R_w 42 dB
- Kirkas laminoitu
- Umpiovi R_w 42 dB

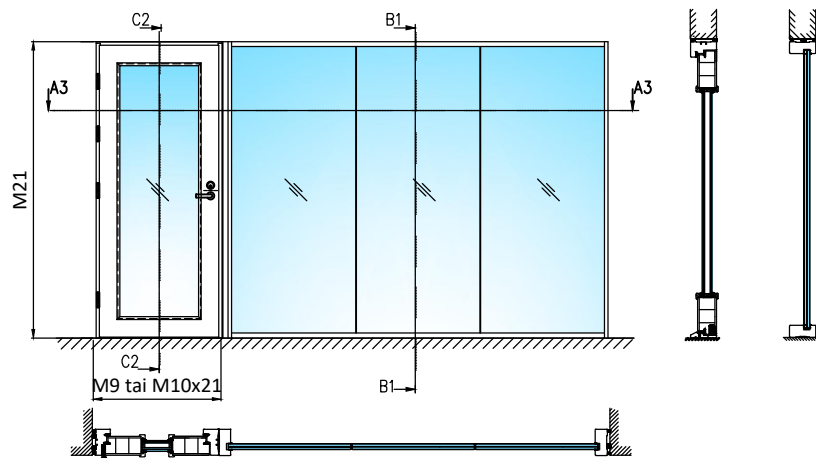

- Kiinteät lasit 20.8Lp (1010.2) tai vastaava R_w 42 dB
- Kirkas laminoitu
- Lasiukollinen ovi R_w 42 dB

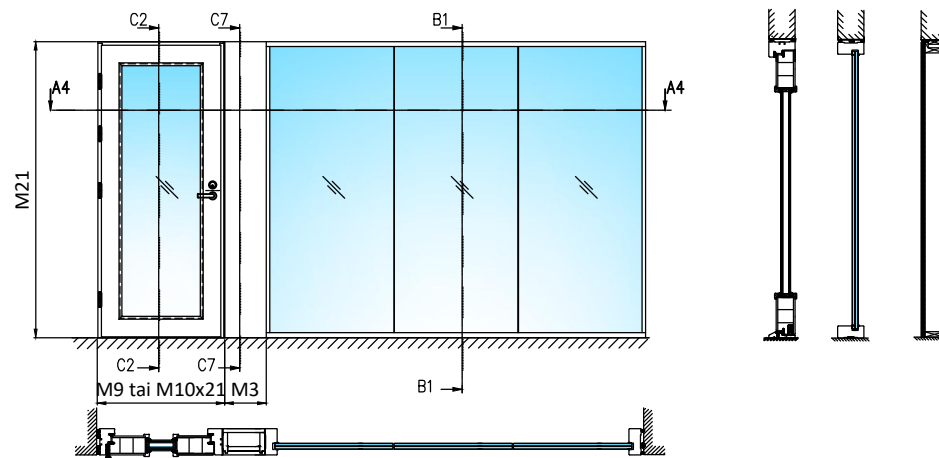

- Kiinteät lasit 20.8Lp (1010.2) tai vastaava R_w 42 dB
- Kirkas laminoitu
- Lasiukollinen ovi R_w 42 dB

HUOM! Karmi- ja kynnysvaihtoehdot esitetty pysty- ja vaakaleikkauksissa!

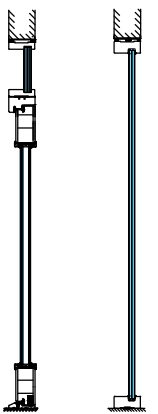
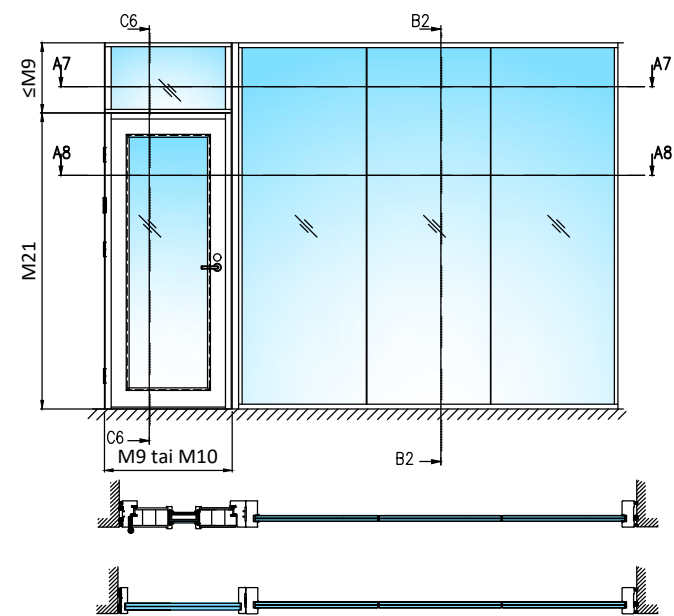
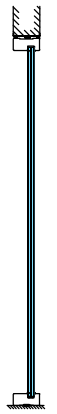
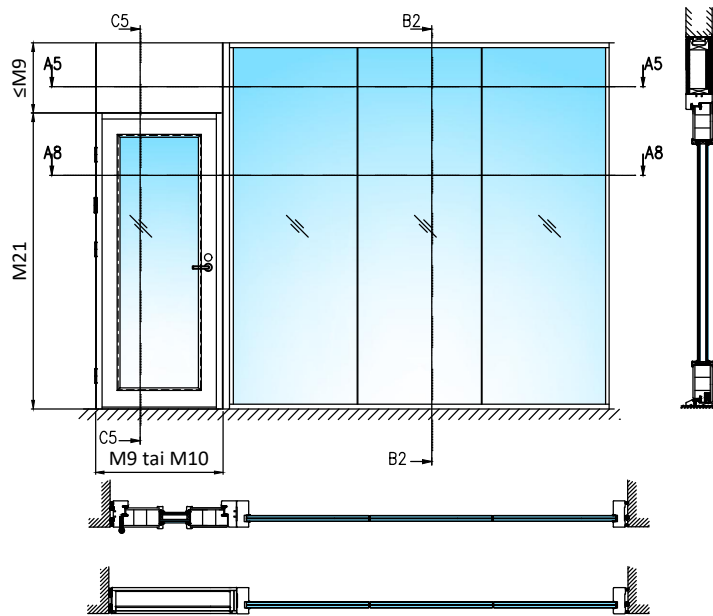
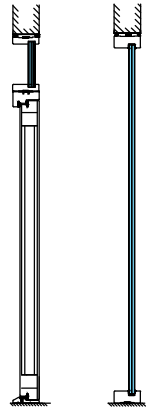
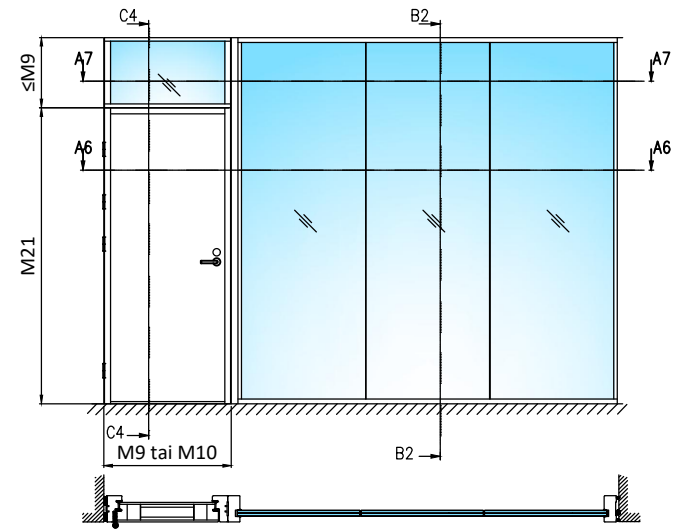
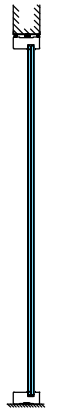
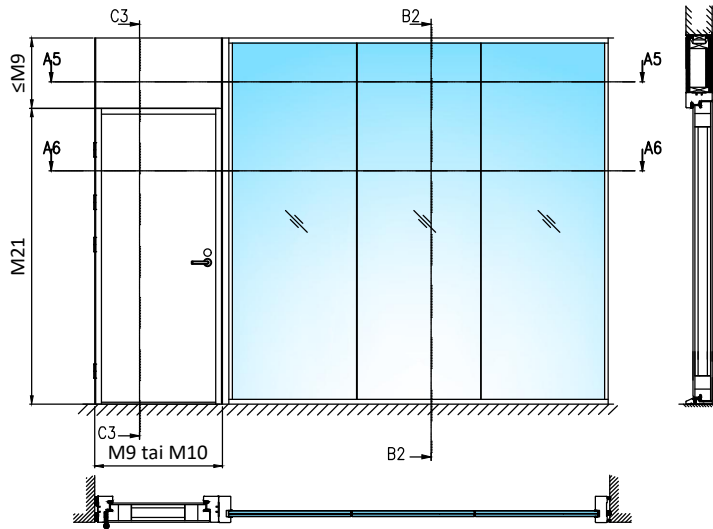

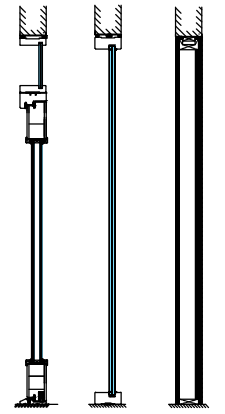
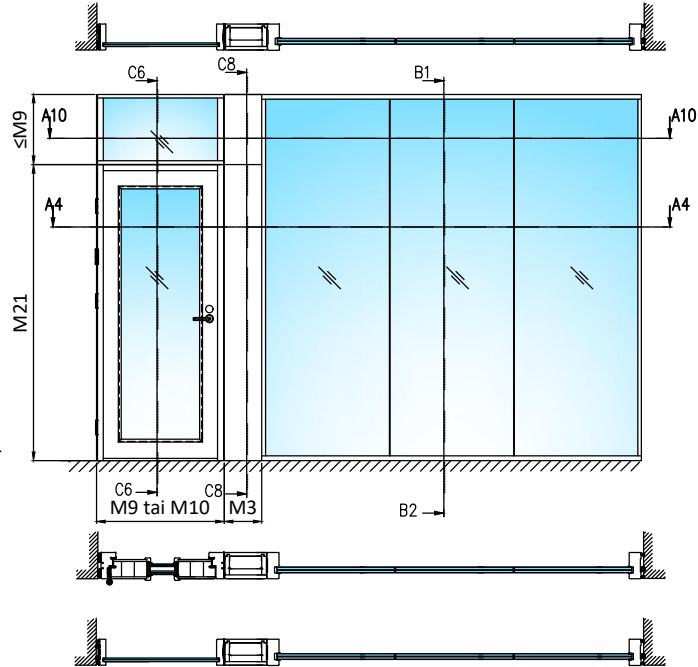
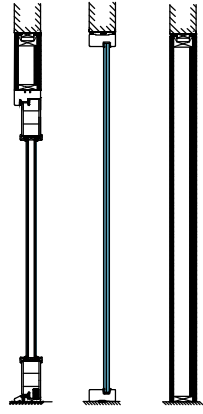
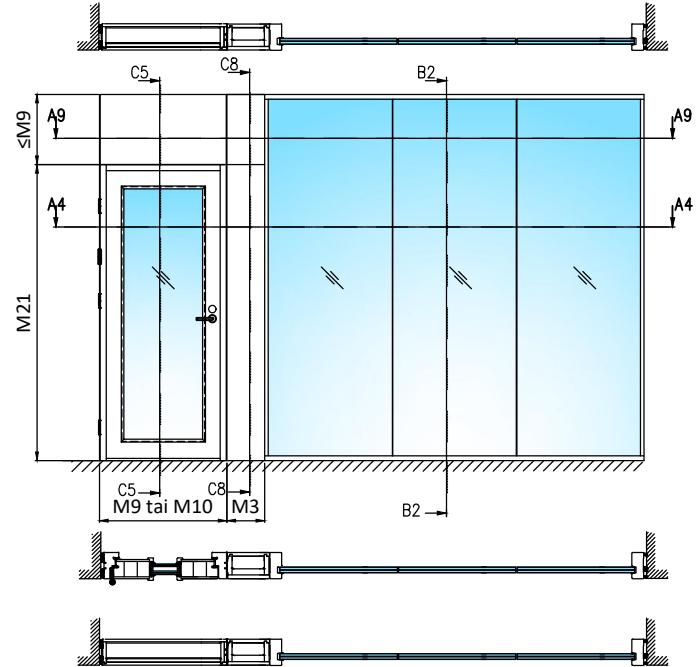
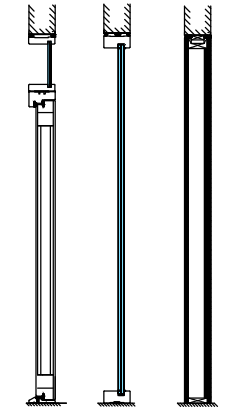
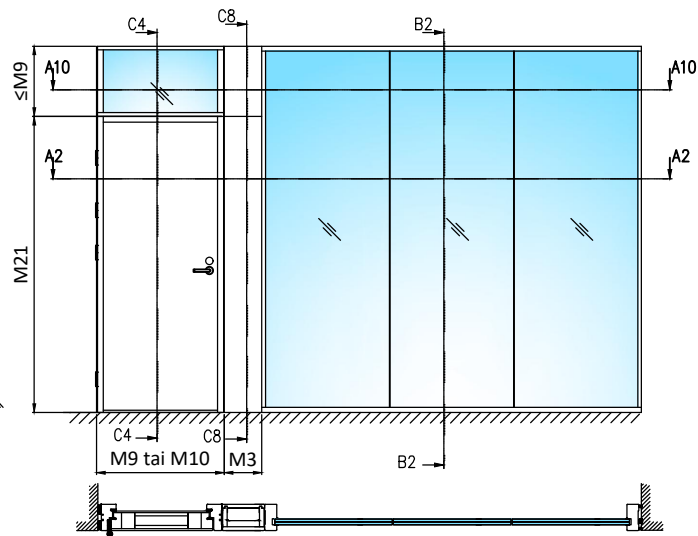
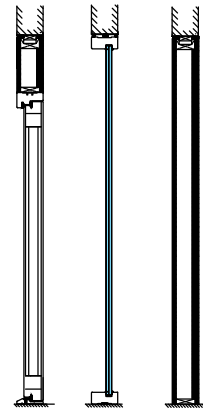
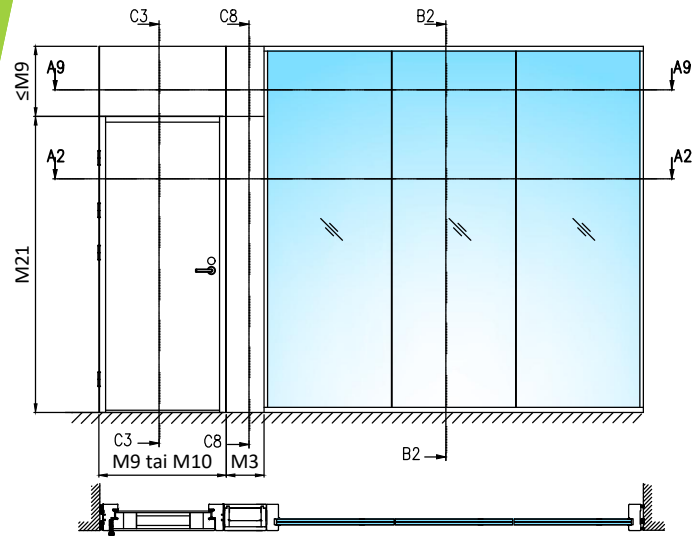

Pystyleikkaukset

- M9 (M10)x21 ulosaukeava umpiovi/
lasiukollinen ovi
- Karmi 54x92 mm
- Sisäänaukeava ovi peilikuvana
- Huom! Alas laskeutuva kynnys noin -1dB

- Otsarakenteen sisään riittävä tukirakenne
oven/seinärakenteen kiinnitystä varten

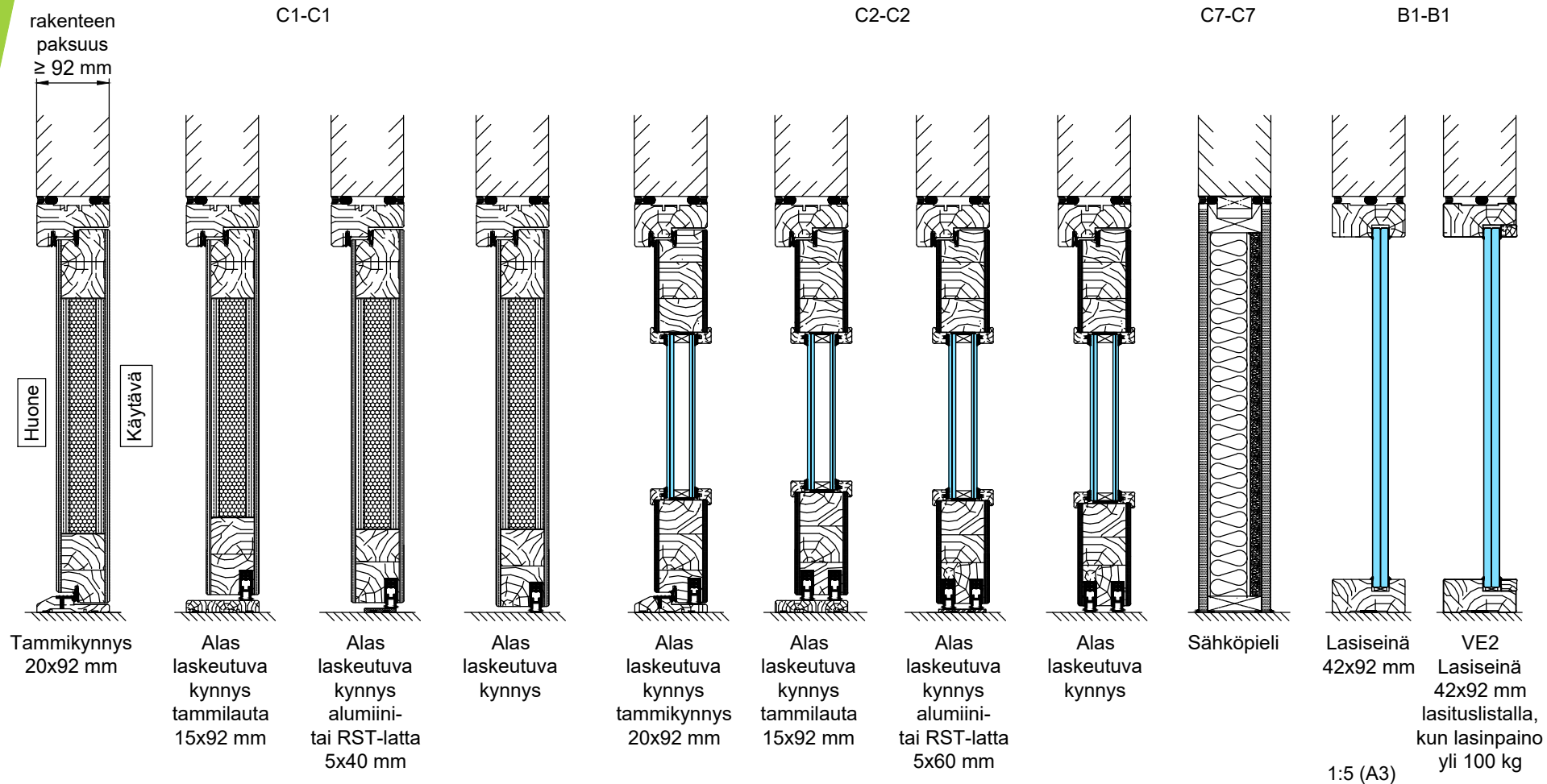

Pystyleikkaukset

- M9 (M10)x21 ulosaukeava umpiovi umpiyläosalla
- Karmi 54x92 mm
- Sisäänaukeava ovi peilikuvana
- Huom! Alas laskeutuva kynnyks noin -1dB

- Otsarakenteen sisään riittävä tukirakenne oven/seinä rakenteen kiinnitystä varten

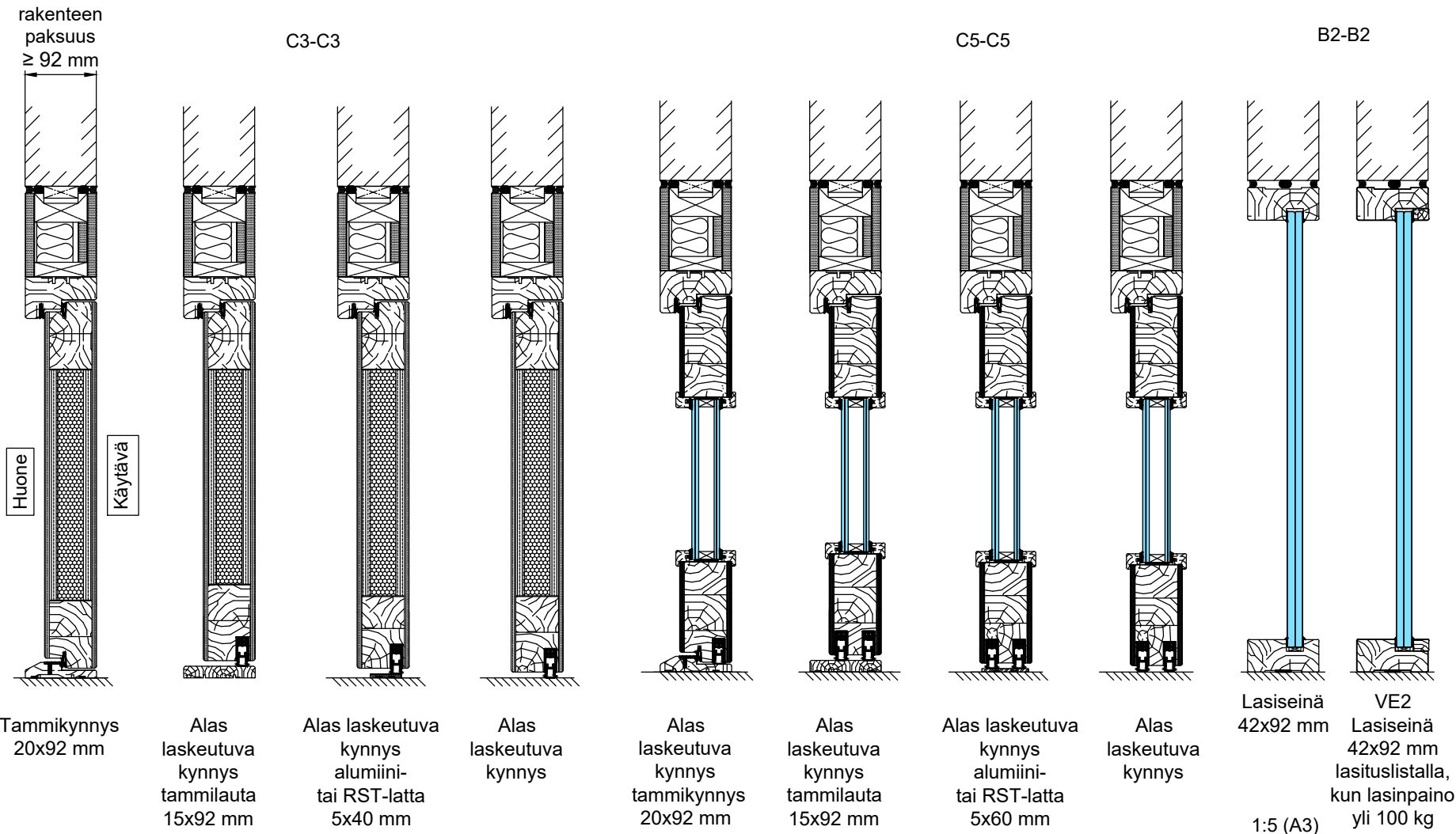

Pystyleikkaukset

- M9 (M10)x21 ulosaukeava lasiaukollinen ovi lasiyläosalla
- Karmi 54x92 mm
- Sisäänaukeava ovi peilikuvana
- Huom! Alas laskeutuva kynnyks noin -1dB

- Otsarakenteen sisään riittävä tukirakenne oven/seinärakenteen kiinnitystä varten

C4-C4

C6-C6

C8-C8

B2-B2

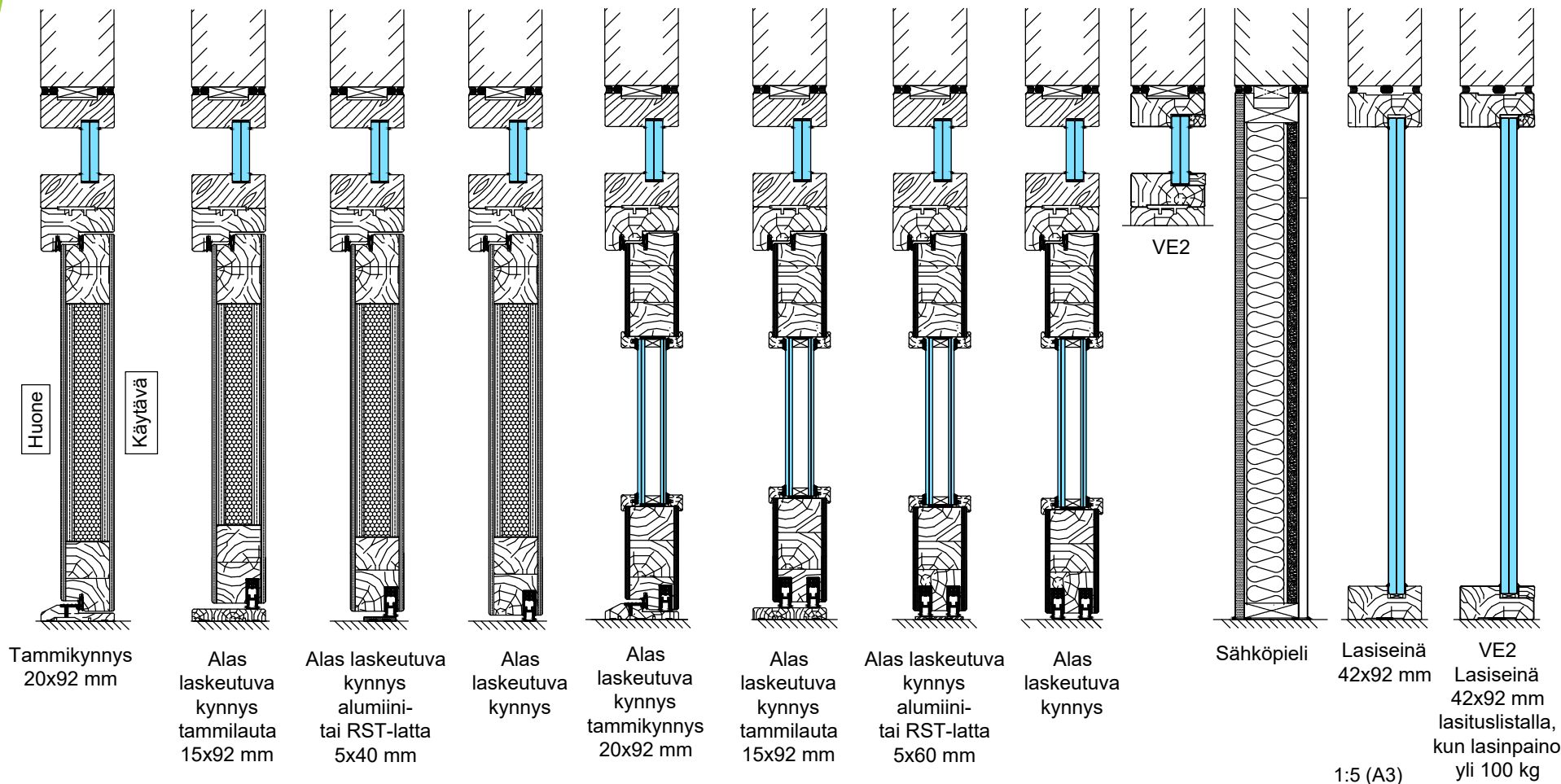

Vaakaleikkaukset

- M9 (M10)x21 umpiovi
- Karmi 54x92 mm
- Ympäriöivän seinärakenteen sisään riittävä tukirakenne oven/seinärakenteen kiinnitystä varten

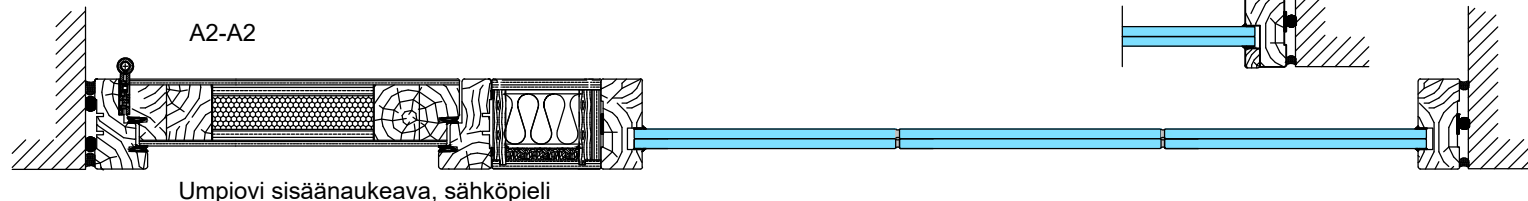
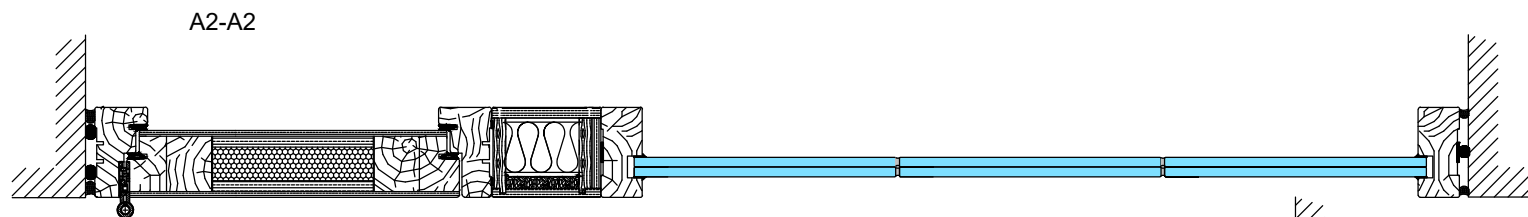
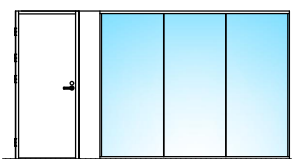
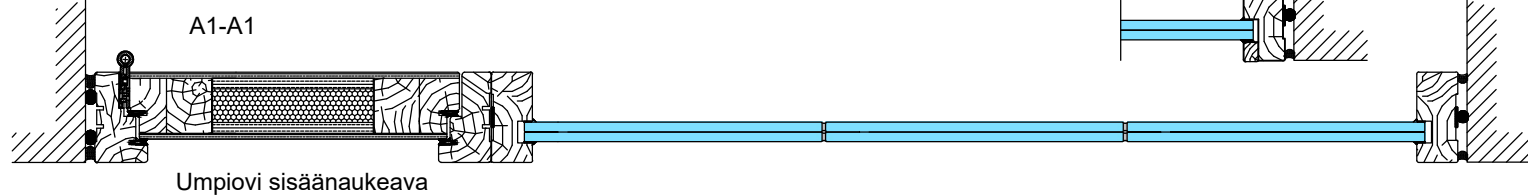
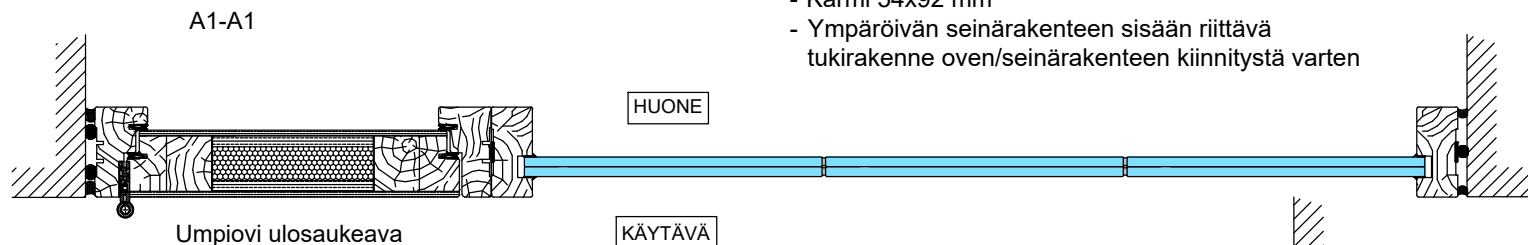
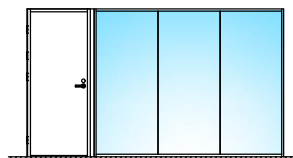

1:5 (A3)

Vaakaleikkaukset

- M9 (M10)x21 lasiaukollinen ovi
- Karmi 54x92 mm
- Ympäröivän seinärakenteen sisään riittävä tukirakenne oven/seinärakenteen kiinnitystä varten

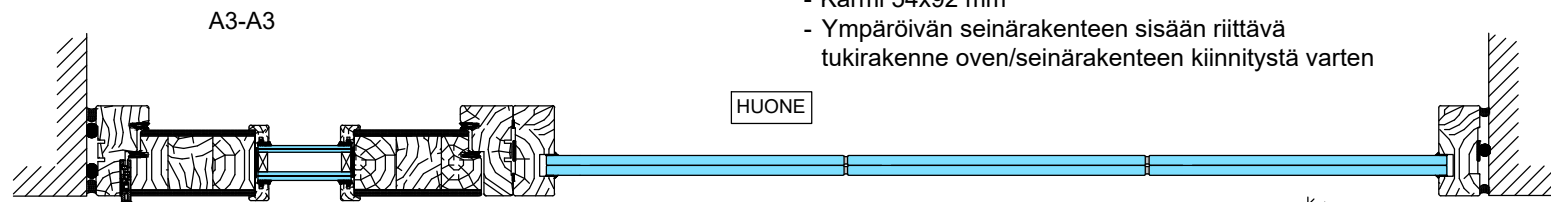
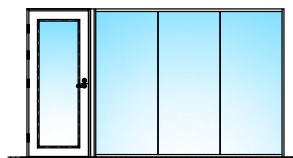

Lasiaukollinen ovi ulosaukeava, apukarmi

KÄYTÄVÄ

- VE2 lasituslistalla

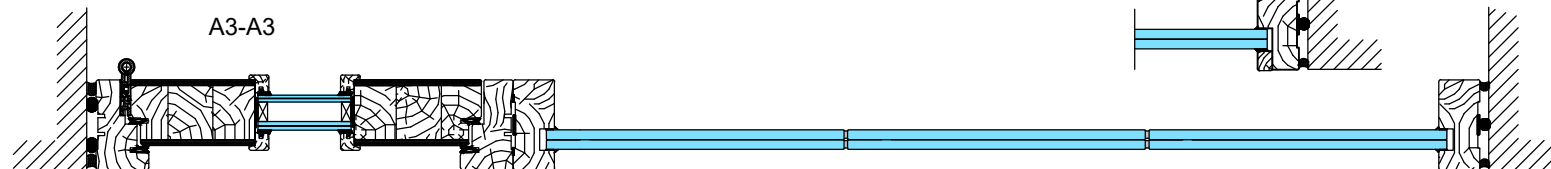

Lasiaukollinen ovi sisäänaukeava, apukarmi

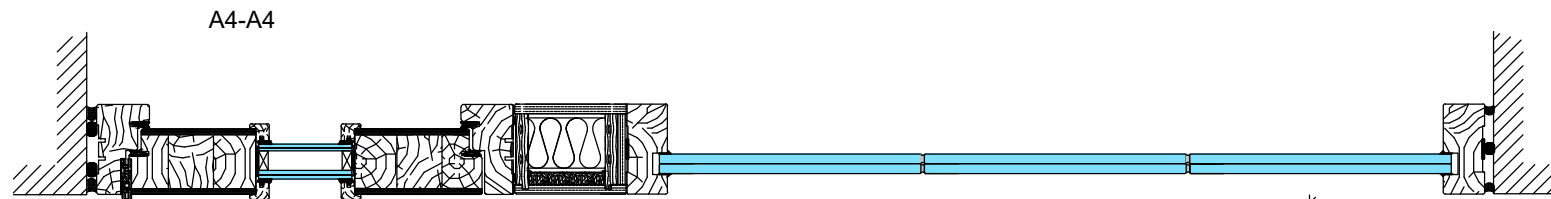
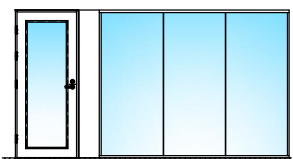

Lasiaukollinen ovi ulosaukeava, sähköpieli

- VE2 lasituslistalla

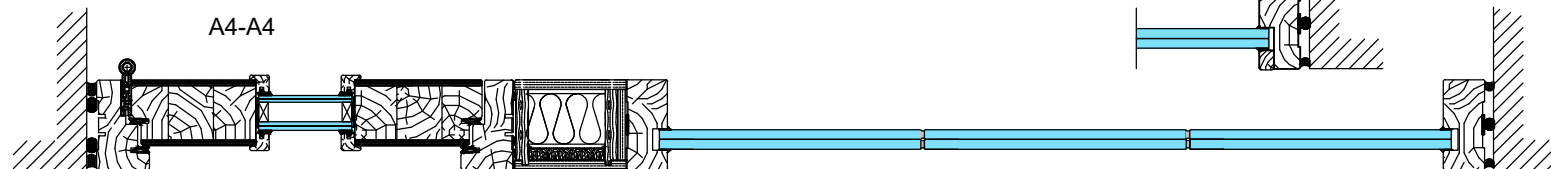

Lasiaukollinen ovi sisäänaukeava, sähköpieli

1:5 (A3)

Vaakaleikkaukset

- M9 (M10)x21 umpiovi umpi- tai lasiyläosalla
- Karmi 54x92 mm
- Ympäröivän seinärakenteen sisään riittävä tukirakenne oven/seinärakenteen kiinnitystä varten

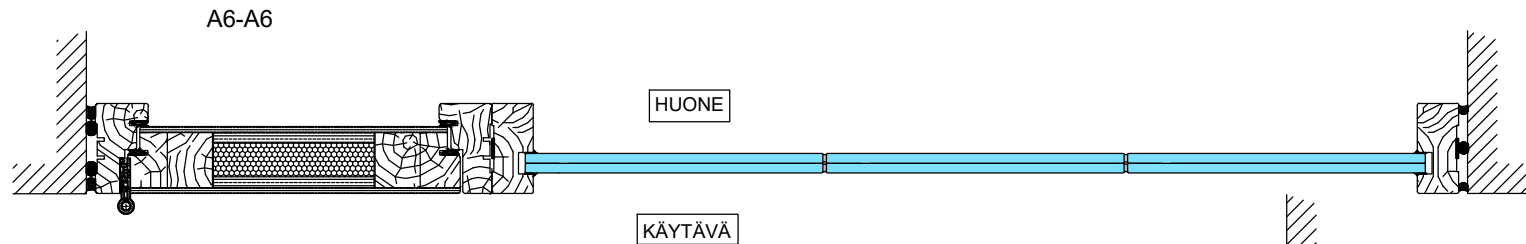
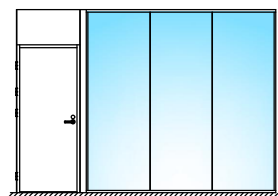

Umpiovi ulosaukeava, apukarmi

- VE2 lasituslistalla

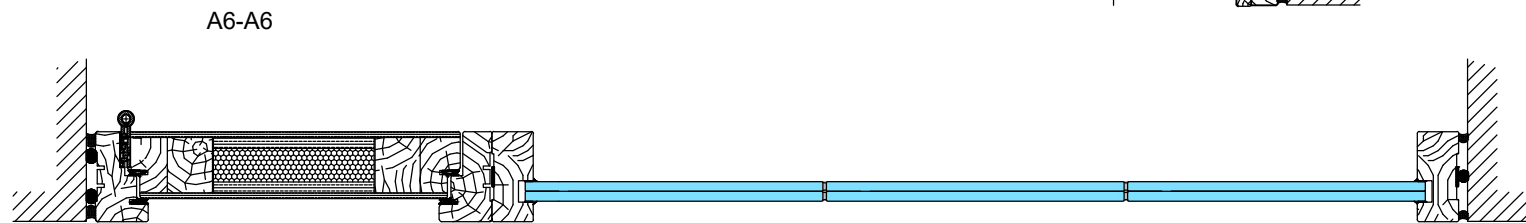
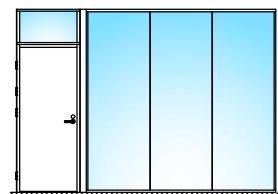

Umpiovi sisäänaukeava, apukarmi

- VE2 lasituslistalla

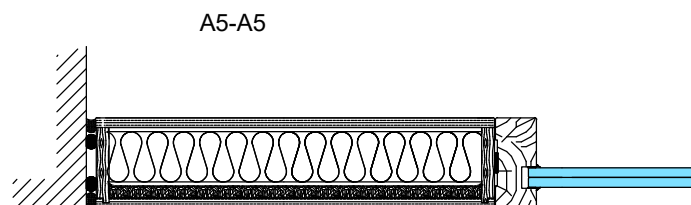

Oven umpiyläosa

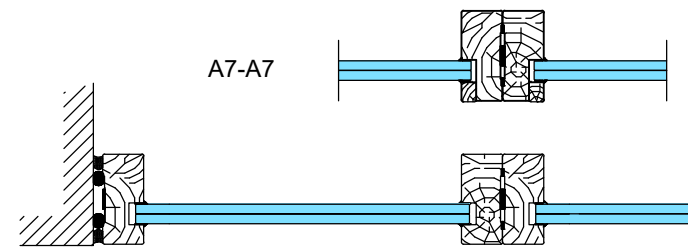

Oven lasiyläosa

1:5 (A3)

Vaakaleikkaukset

- M9 (M10)x21 lasiaukollinen ovi umpi- tai lasiyläosalla
- Karmi 54x92 mm
- Ympäröivän seinärakenteen sisään riittävä tukirakenne oven/seinärakenteen kiinnitystä varten

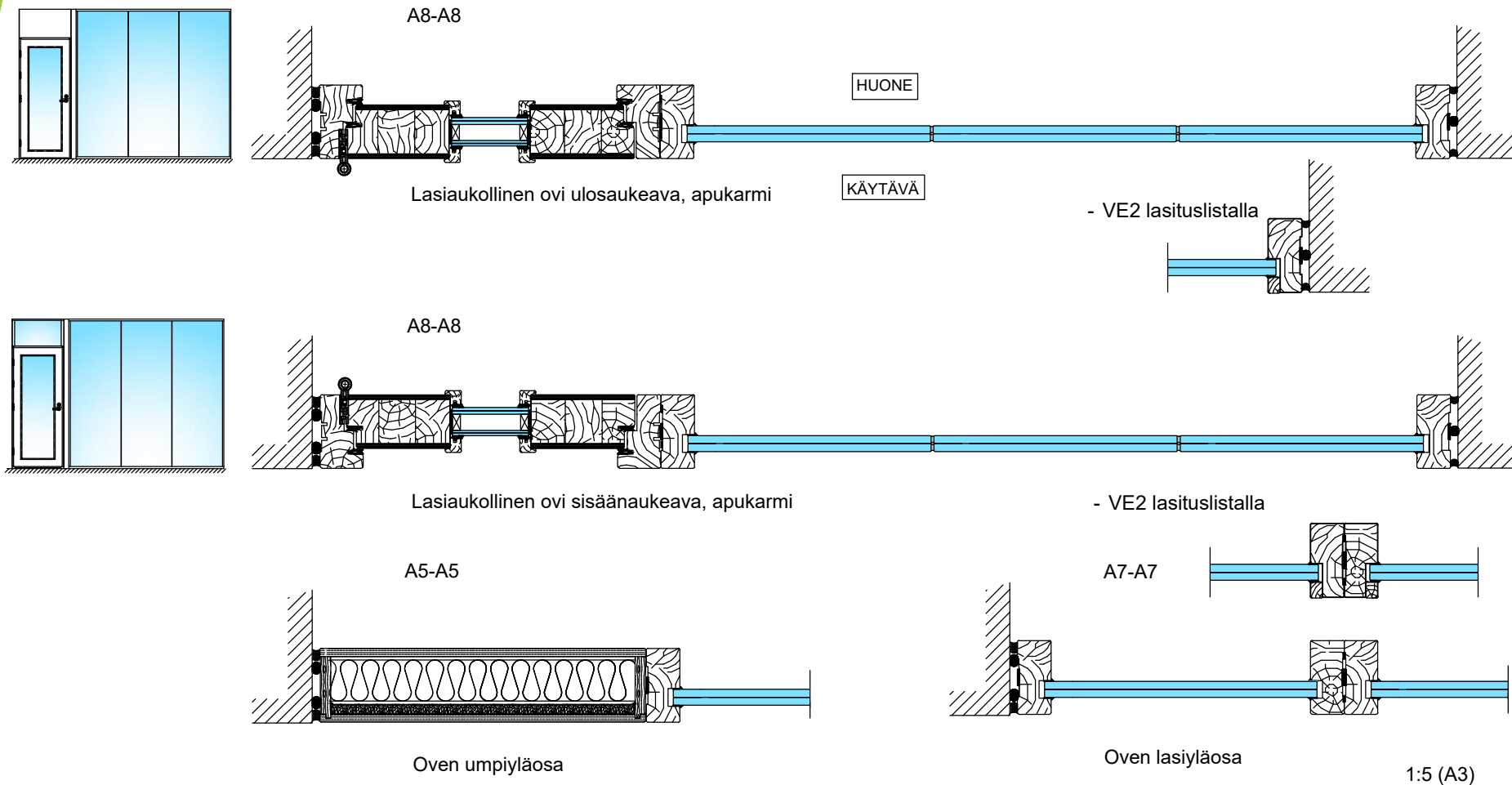

Vaakaleikkaukset

- M9 (M10)x21 umpiovi umpi- tai lasiyläosalla
- Karmi 54x92 mm
- Ympäröivän seinärakenteen sisään riittävä tukirakenne oven/seinärakenteen kiinnitystä varten

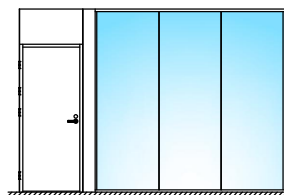

A2-A2

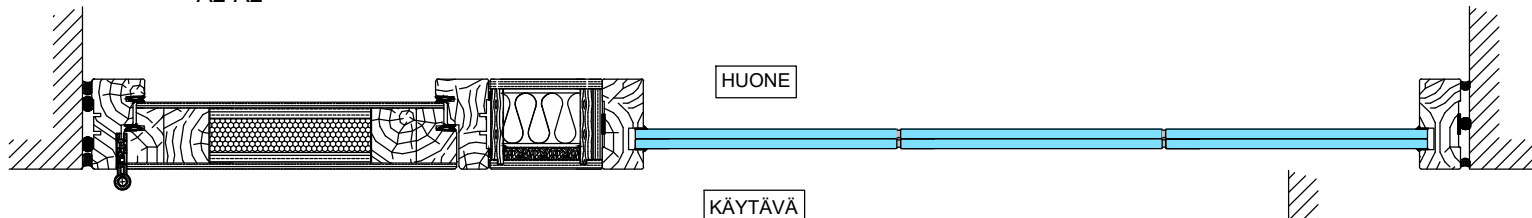

Umpiovi ulosaukeava, sähköpieli

- VE2 lasituslistalla

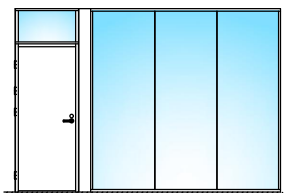
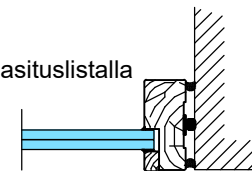

A2-A2

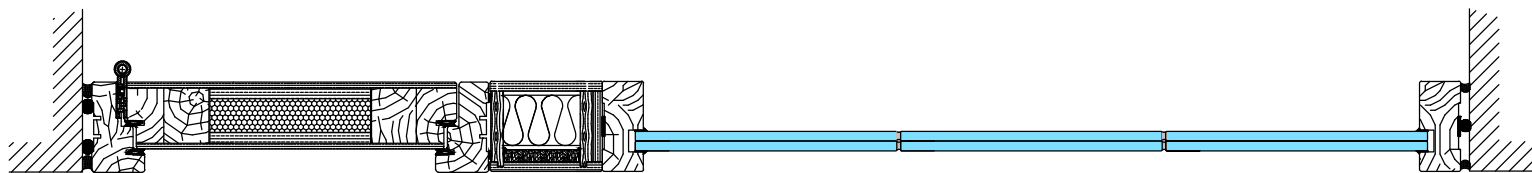

Umpiovi sisäänaukeava, sähköpieli

- VE2 lasituslistalla

A9-A9

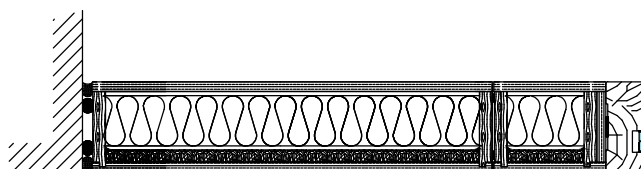

Oven umpiyläosa

A10-A10

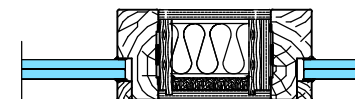

Oven lasiyläosa

1:5 (A3)

Vaakaleikkaukset

- M9 (M10)x21 lasiaukollinen ovi umpi- tai lasiyläosalla
- Karmi 54x92 mm
- Ympäröivän seinärakenteen sisään riittävä tukirakenne oven/seinärakenteen kiinnitystä varten

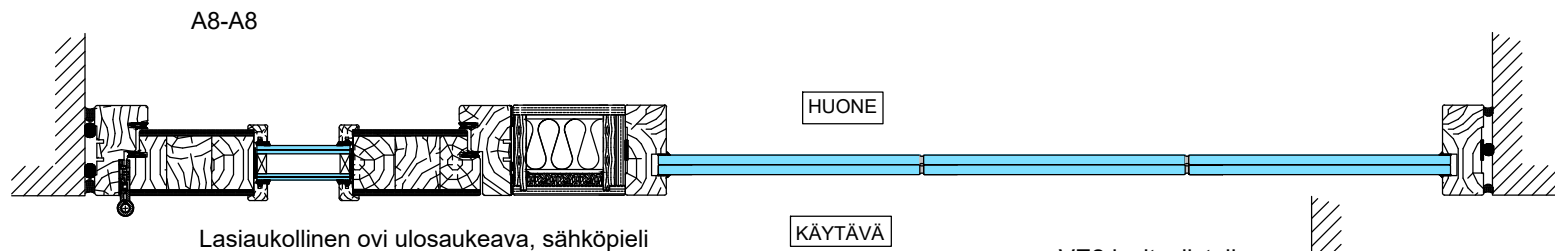
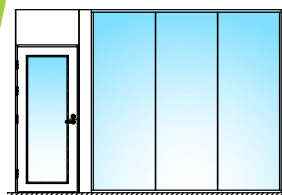

- VE2 lasituslistalla

